



impekk

Closet Storage System



Looking for closet organization solutions? Impekk provides many options that are functional and space saving, while maintaining any storage area neat and organized. This product line offers a variety of sliding door hardware, shelf supports, rods, closet lights, a pull-out closet mirror and a folding ironing board.

A world of solutions, service included!



impekk

TABLE OF CONTENTS



p. 04



p. 08



p. 11

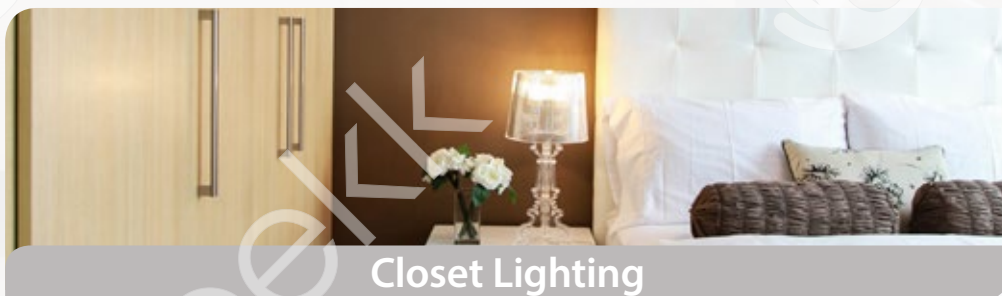

p. 17



Sliding Door
Hardware

p. 04-07

Rail System for Sliding Doors

Description & Features

- Perfect for a rustic decor.
- Easy to slide open.
- 2000 mm spliced steel flat bar.
- Weight Capacity: 109kg (240lbs)
- Compatible with our soft-closing mechanism, sold separately (p. 07).



Available Finishes:



Stainless Steel (SS)

Black (NR)

Components Included

- 2 Sliding Rails
- 2 Rollers
- 5 Wall Mounts
- 2 Door Stops
- 1 Floor Guide
- 1 Anti-jump Disk
- Hardware Kit

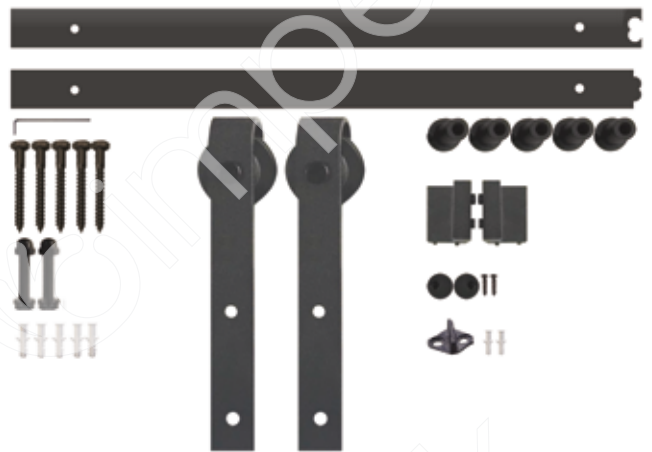

Code	Material	Finish (xx)	Total Length mm (in)	Weight Capacity
IMPK-23SDT78-SS	Steel	SS	2000 (78 ^{3/4})	109kg (240lbs)
IMPK-23IDT78-NR	Steel	NR	2000 (78 ^{3/4})	109kg (240lbs)

Rail System for Sliding Doors (cont.)

Description & Features

- Perfect for a modern decor.
- Easy to slide open.
- 2000 mm steel tube-type rail.
- WeightCapacity: 90.7 kg (200 lbs)

Available Finish:



Stainless Steel (SS)

Components Included

- 2 Sliding Rails
- 2 Rollers
- 5 Wall Mounts
- 2 Door Stops
- 1 Floor Guide
- 1 Rail Connector
- 1 Anti-jump Disk
- Hardware Kit



Code	Material	Finish (xx)	Total Length mm (in)	Weight Capacity
IMPK-22SDT78-SS	Steel	SS	2000 (78 ^{3/4})	90.7 kg (200 lbs)

Sliding Door Accessories



Code	Finish (xx)	Total Length mm (in)	CC mm (in)	Diameter mm (in)
IMPK-YMLS12W-SS	SS	400 (15 ^{3/4} "	300 (11 ^{13/16})	25 (1)
IMPK-YMLS12W-NR	NR	400 (15 ^{3/4} "	300 (11 ^{13/16})	25 (1)



Code	Finish (xx)	Total Length mm (in)	CC mm (in)	Total Depth mm (in)
IMPK-YMLS14-SS	SS	145 (5 ^{45/64} "	90 (3 ^{35/64})	14 (9/16)
IMPK-YMLS14-NR	NR	145 (5 ^{45/64} "	90 (3 ^{35/64})	14 (9/16)



* Compatible with IMPK-23IDT78-NR & IMPK-23SDT78-SS only (p. 05).

Code	Finish (xx)	Description
IMPK-YMXW22-NR	NR	Soft-closing mechanism for sliding door hardware.



**Closet
Organization**

p. 08-10

Pull-out Closet Mirror

Description & Features

- Heavy-duty ball bearing slides.
- Mirror pivots before sliding back into the cabinet.
- Cabinet minimum dimensions: 406 x 1220 mm (16" x 48").

Components Included

- 2 Ball Bearing Slides
- 1 Mirror
- 1 set of pivoting Brackets & Hardware Kit

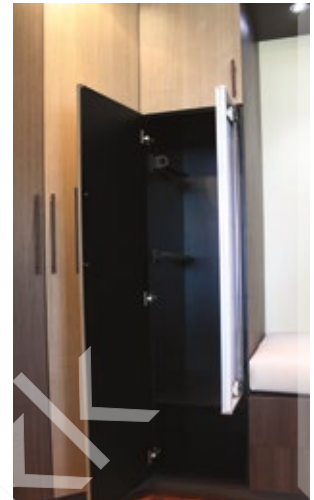
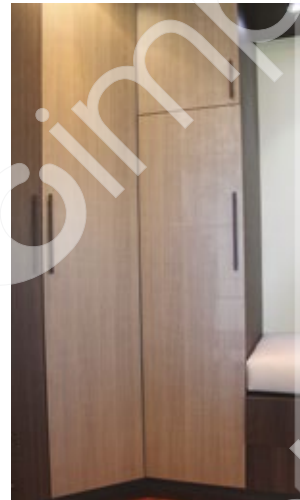

Code	Exterior Colour	Ext. Dimensions. mm (in)			Case
		W	D	H	
LH-MIRR	Silver	394 (15 1/2)	38 (1 1/2)	1219 (48)	1

Folding Ironing Board

Description & Features

- 800mm bottom mount ironing board.
- Insulated silver cover.
- Folds in half.
- Minimum cabinet depth: 152 mm (6")

Components Included

- 1 Sliding Base
- 1 Folding Board
- 1 Cover
- Hardware Kit



Code	Exterior Colour	Ext. Dimensions. mm (in)			Case
		W	D	H	
LH-IRON/FB	Silver	305 (12)	485 (19 ^{3/32})	152 (6)	1

A modern, organized closet with shelves of folded clothes, drawers, and shoe racks. The closet is filled with neatly folded clothing, including shirts, pants, and towels, in various colors like white, grey, blue, and yellow. The bottom section features several drawers and shoe racks filled with various styles of shoes, including sneakers, loafers, and sandals. A large, dark grey circular graphic is overlaid in the center of the image, containing the text 'Closet Hardware p. 11-16'.

**Closet
Hardware**
p. 11-16

Decorative Shelf Fences



- Easy to install.
- Reduces the amount of construction materials of the drawer.

Code	Colours	Length mm (in)	Height mm (in)	Case
SF318SGA	Grey	343 (13 1/2)	35 (1 3/8)	100
SF394GA		419 (16 1/2)		
SF370SGA		495 (19 1/2)		
SF495SGA		572 (22 1/2)		
SF623SGA		648 (25 1/2)		
SF699SGA		724 (28 1/2)		

Sliding Drawer Side

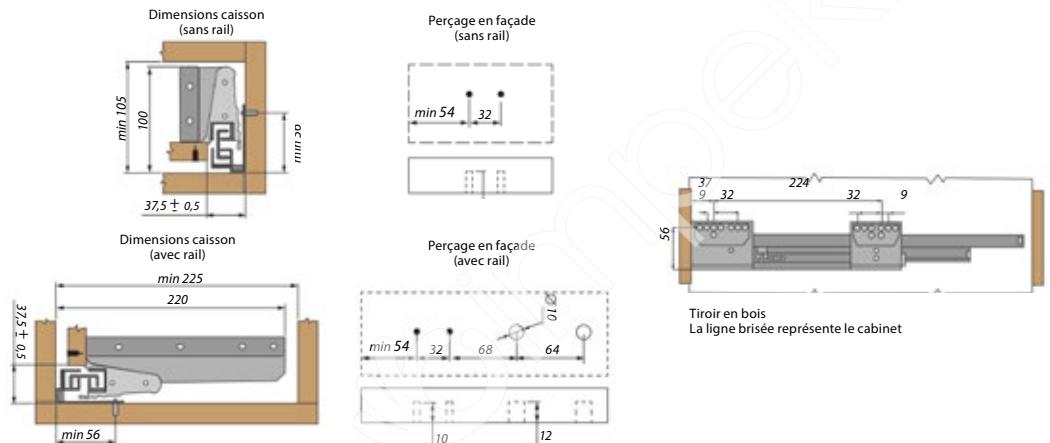

Code	Description	Colour	Total Length mm (in)	Total Height mm (in)	Case
B686GA-86-350	Drawer side with integrated slides.	Silver Grey	350 (13 25/32)	88 (3 15/32)	1
B686GA-86-400			400 (15 3/4)		
B686GA-86-450			450 (17 23/32)		
B686GA-86-500			500 (19 11/16)		
B686GA-86-550			550 (21 21/32)		
B686R-204-400	Side rail option for deep drawers.	Silver Grey	400 (15 3/4)	204 (8 1/32)	25
B686R-204-450			450 (17 23/32)		
B686R-204-500			500 (19 11/16)		
B686R-204-550			550 (21 21/32)		

Closet Rods & Flanges

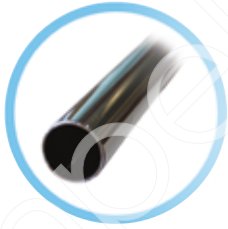

5595CH-8

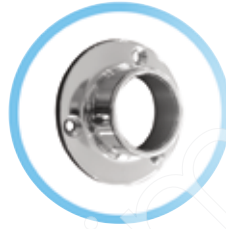

596CL-1 5/16



596OP-1 5/16

Code	Finish	Description	Ext. Dimensions mm (in)			Case
			W	D	H	
5595CH-8	Chrome	Round closet rod.	2.4 m (94 1/2)	—	ø 33 (1 5/16)	5
596CL-1 5/16		Closed flange for 34 mm round rods.	—	23 (29/32)	ø 69 (2 23/32)	250
596OP-1 5/16		Opened flange for 34 mm round rods.	—	23 (29/32)	ø 69 (2 23/32)	250

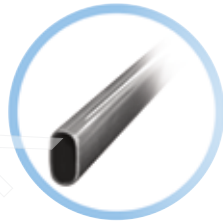

597CH-15/30/2438



0597 Series

Code	Finish	Description	Ext. Dimensions mm (in)			Case
			W	D	H	
597CH15/30-2438	Chrome	Oval closet rod.	2.4 m (94 1/2)	15 (19/32)	45 (1 25/32)	250
0597-NC	Nickel	Closed flange for 15x30mm closet rods.	19 (3/4)	15 (19/32)	30 (1 3/16)	
0597-D5NC	Nickel	Opened flange for 15x30mm rods (dowels).	19 (3/4)	17 (21/32)	45 (1 25/32)	

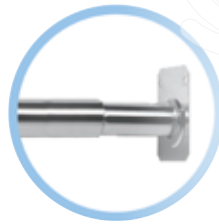

597Z & 598Z Series

Code	Finish	Description	Ext. Dimensions mm (in)			Case
			W	D	H	
597Z-1830	Zinc	Round extending closet rod with mounting plates.	457-762 (18-30)	-	ø 25 (1)	10
598Z-1830		Round extending closet rod with welded mounting plates.	457-762 (18-30)			
597Z-3048		Round extending closet rod with mounting plates.	762-1219 (30-48)			
598Z-3048		Tringle ronde extensible avec plaques soudées.	762-1219 (30-48)			

Shelf Supports

56.7kg
125lbs

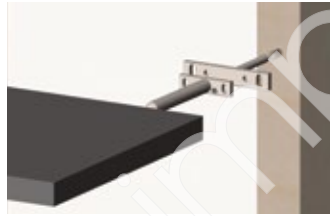

Code	Finish	Drilling Diameter (shelf) mm (in)	Drilling Diameter (wall) mm (in)	Material	Case
IMPK-HDSS-01Z	Zinc	14 (9/16)	7,9 (5/16)	Steel	500



0100-NC



100T-N5



100V-LT

Code	Finish	Drilling Diameter mm (in)	Material	Case
0100-NC	Nickel	6,35 (1/4)	Steel	2500
100T-N5	Nickel	5 (3/16)	Steel	
100V-LT	Brass & Brown	5 (3/16)	Steel & Plastic	



0101 & 101Series



0102-xx

Code	Finish	Drilling Diameter mm (in)	Material	Case
0101-CH	Chrome	7 (9/32)	Steel	5000
0101-LT	Brass	7 (9/32)		
101C-05	Chrome	5 (3/16)		
101L-5	Brass	5 (3/16)		
101C-04	Chrome	4 (5/32)		
0102-CH	Chrome	7,2 (9/32)		
0102-LT	Brass	7,2 (9/32)		

Shelf Supports (cont.)



108Z-05



108Z-CL

Code	Finish	Drilling Diameter mm (in)	Material	Case
108Z-05	Zinc	5 (3/16)	Steel	5 000
108Z-CL	Zinc & Clear	5 (3/16)	Steel & Plastic	



Code	Finish	Drilling Diameter mm (in)	Material	Case
6129-7 3/4	Zinc	196,9 (7 3/4)	Steel	250



0107-xx



0111-xx



109Z-CL

Code	Finish	Drilling Diameter mm (in)	Material	Case
0107-BL	White	5 (3/16)	Plastic	10 000
0107-CL	Clear	5 (3/16)	Plastic	10 000
0111-BL	White	6,35 (1/4)	Plastic	10 000
0111-BR	Brown	5 (3/16)	Plastic	10 000
0111-CL	Clear	5 (3/16)	Plastic	10 000
0111-NR	Black	6,35 (1/4)	Plastic	10 000
109Z-CL	Clear	5 (3/16)	Plastic & Steel	100

Shelf Supports (cont.)



Code	Finish	Drilling Diameter mm (in)	Material	Case
113A-BL	White	16 (5/8)	Plastic	10 000
113A-CL	Clear			



Code	Finish	Drilling Diameter mm (in)	Material	Case
0115-CL	Clear	4 (5/32)	Plastic	10 000



Closet
Lighting
p. 17-18

Closet Lighting



Top View



K904LED-BL1-EN & K904LED-BL2-EN



K904LED-BL2-SF

Code	Description	Power	Dimensions mm (in)	Finish
K904LED-BL1/EN	1 LED recessed light.	12V, 1A	ø 60 x 20 (2 3/8 x 3/4)	White
K904LED-BL2/EN	Set of 2 LED recessed lights.		ø 60 x 20 (2 3/8 x 3/4)	
K904LED-BL2-SF	Set of 2 LED surface lights.		ø 60 x 30 (2 3/8 x 1 3/16)	



Code	Description	Power	Dimensions mm (in)	Finish
LEDPUCK18-W-S	LED recessed light.	12V, 1A	ø 71 x 20 (2 3/4 x 3/4)	Brushed Nickel



Code	Description	Power	Dimensions mm (in)	Finish
LH-LED-03-BS	LED tube light.	3 AAA batteries	190 x 23 x 23 (7 1/2 x 7/8 x 7/8)	White



CONSULT OUR OTHER BROCHURES

